

INSTRUKCJA MONTAŻU

PARAWAN NAWANNOWY 1-SKRZYDŁOWY

PRIME I

Indeks:

PNP-1S

Wymiary:





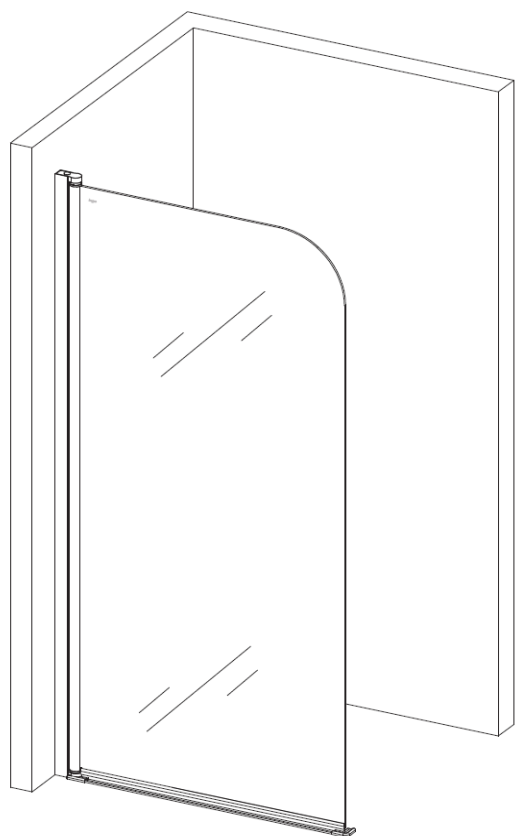





70 x 140 cm

besco







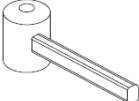
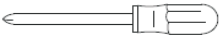
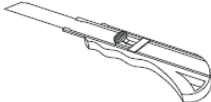
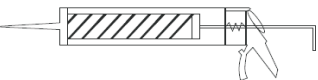

Więcej informacji: www.besco.eu

LISTA CZĘŚCI

numer części	indeks	opis	j.m.	ilość	szkic
P01	PSPRUP01C1	Profil ścienny PRIME, dł. 1400 mm, chrom	szt.	1	
P02	PUPR1P02C1	Aluminiowy profil uszczelniający PRIME, dł. 620 mm, chrom	szt.	1	
U01	UDPR1U01P1	Uszczelka dolna PRIME, dł. 635 mm, bezbarwna	szt.	1	
M01	MPPRUM01C1	Maskownica / zaślepka profilu uszczelniającego, komplet lewa/prawa, chrom	szt.	2	
M02	MPPRUM02C1	Maskownica / zaślepka profilu uszczelniającego, narożna, chrom	szt.	1	
M03	MBPRUM03C1	Maskownica / zaślepka zawiasu kolumnowego, chrom	szt.	1	
W01	WKUUUW01D1	Kołek montażowy, Ø6 mm, biały	szt.	3	
W02	WRUUUW02C1	Wkręt ST4x30, chrom	szt.	3	
W03	WZUUUW03C1	Wkręt ST4x12 + zaślepka chrom, komplet	szt.	3	
S01	SRPR1S01P1	Szyba ruchoma PRIME, płaska, z zawiasem kolumnowym, 1353 x 645 x 5 mm, przejrzysta	szt.	1	

SUGEROWANE NARZĘDZIA

ołówek		gumowy młotek	
śrubokręt krzyżakowy		nóż do tapet	
silikon bezbarwny sanitarny		wiertło Ø6 mm	
poziomica		wiertło Ø3 mm	
miarka (min. 2 metry)		wiertarka	

SCHEMAT PARAWANU

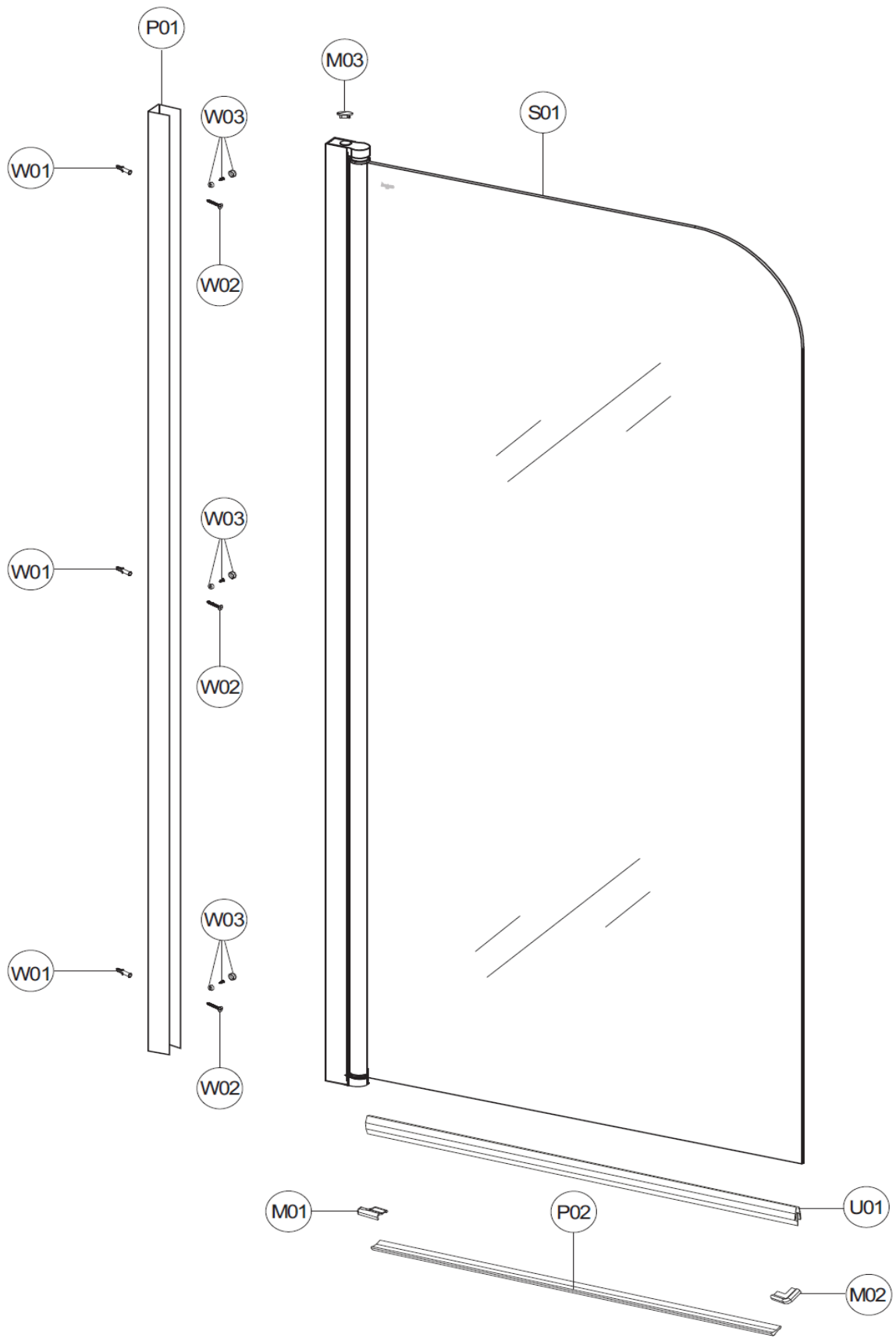

INSTRUKCJA MONTAŻU

1

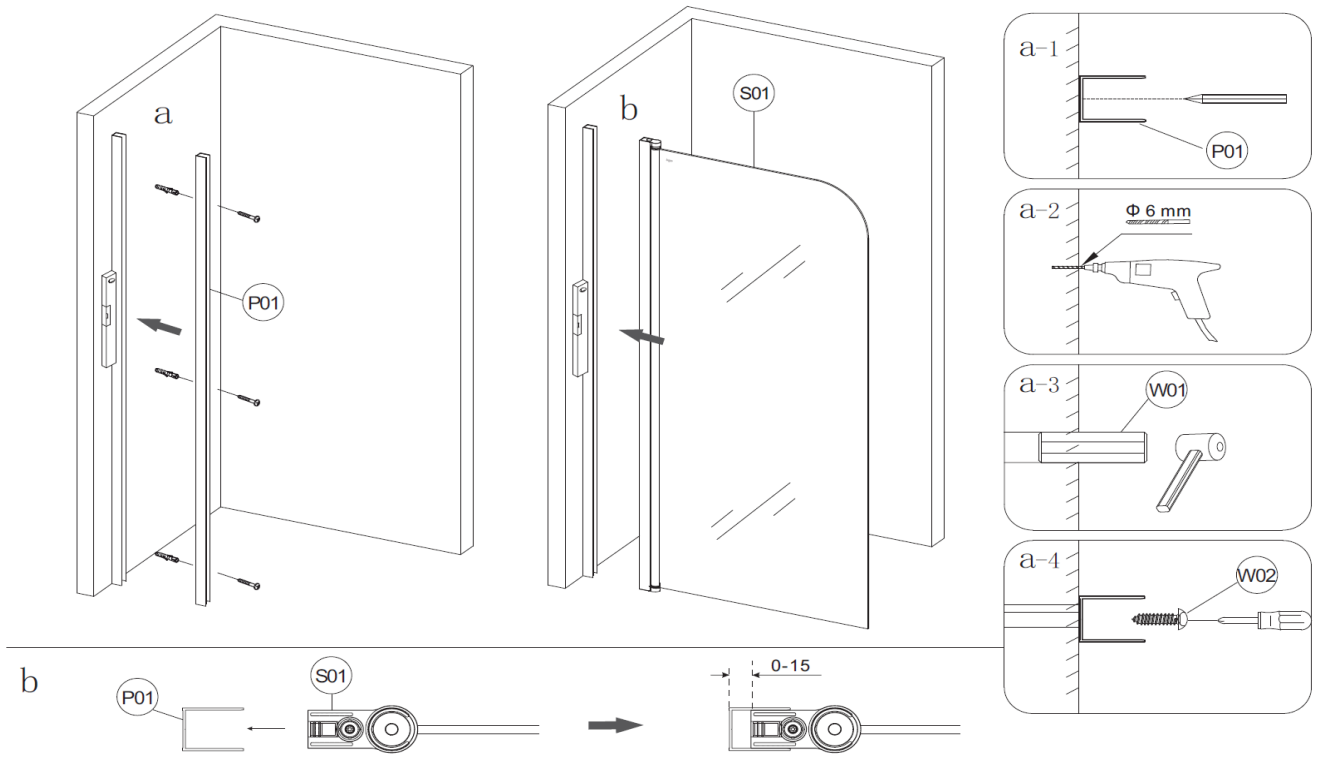

2

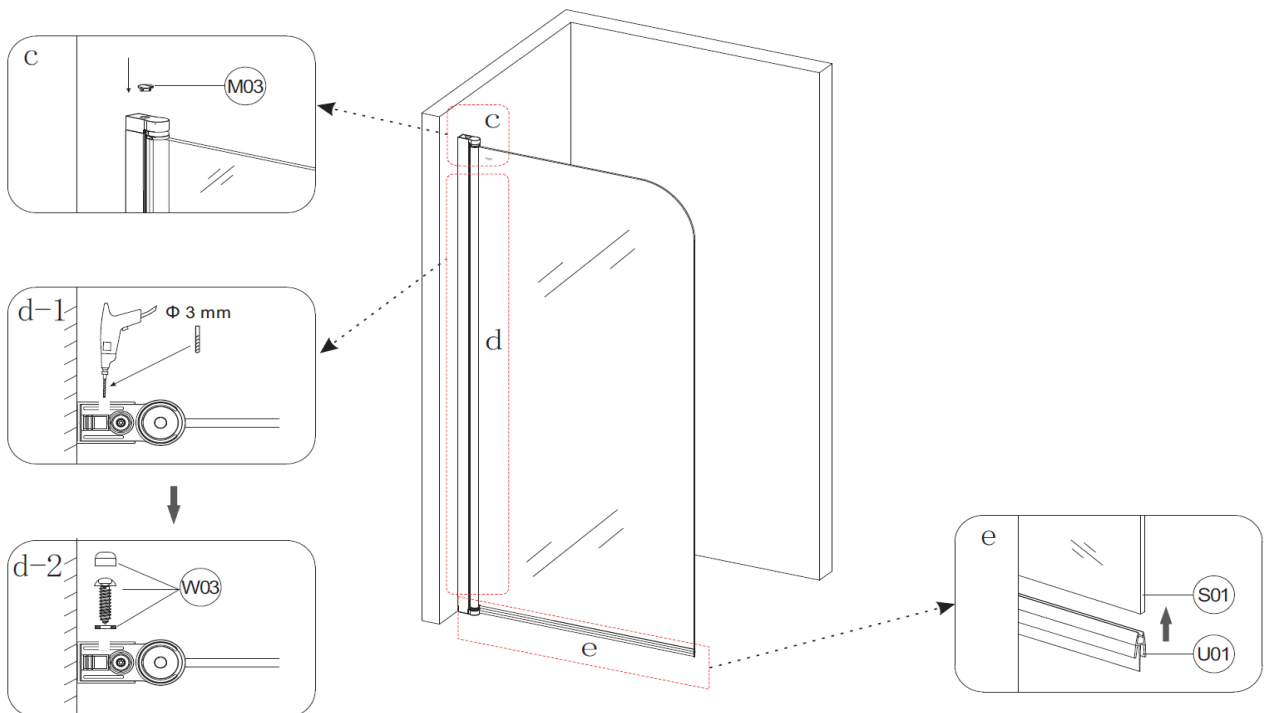

3

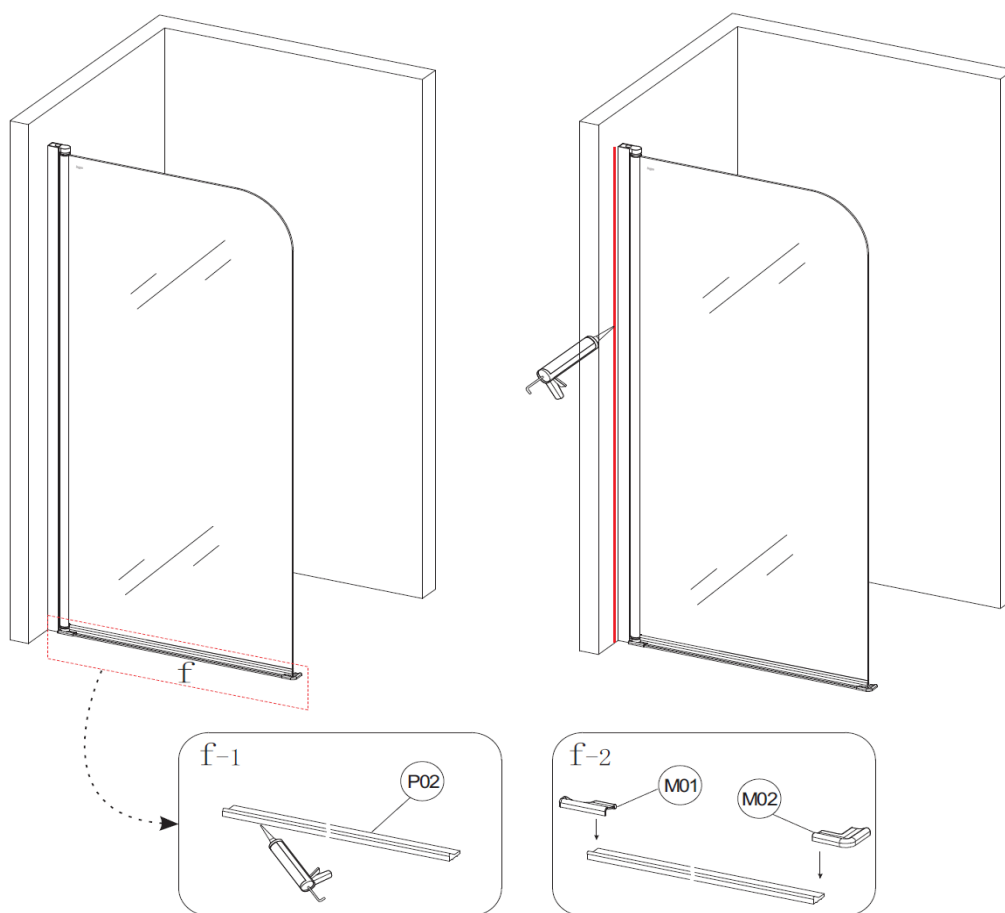

Zalecenia eksploatacyjne:

Nie należy używać parawanu nawannowego przez 48h od momentu zakończenia jego montażu.

Do czyszczenia nie należy stosować środków żrących ani zawierających substancji ściernych.

Rekomendowany środek:

Besco Professional "Kabiny i parawany"

Najczęściej popełniane błędy montażowe:

- 1) Brak wypoziomowania podłoża (wannы)
- 2) Nieprawidłowe umieszczenie szyby z zawiasem kolumnowym w profilu ściennym - szyba po umieszczeniu w profilu ściennym powinna być równoległa do krawędzi wannы
- 3) Brak wypoziomowania parawanu po umieszczeniu w profilu ściennym
- 4) Nakładanie "zimnej uszczelki" - uszczelka przed montażem powinna być przechowywana minimum 12 godzin w temperaturze pokojowej
- 5) Przycięcie uszczelki - uszczelka jest dopasowana do parawanu fabrycznie

Jak dbać o parawany nawannowe Besco?



Wystarczy pamiętać o kilku podstawowych zasadach, aby móc przez długie lata bezproblemowo cieszyć się swoim parawanem nawannowym.

Ważne jest stosowanie jedynie miękkich gąbek i ściereczek oraz płynów nie zawierających substancji żrących czy cząsteczek szorujących, gdyż bardzo łatwo mogą one zniszczyć szklaną powierzchnię parawanu.

Aby ułatwić naszym Klientom codzienną pielęgnację naszych wyrobów oraz zapewnić ich komfortowe użytkowanie, wprowadziliśmy do oferty profesjonalny środek do parawanów nawannowych:

Besco Professional "Kabiny i parawany"

DANE KONTAKTOWE:

Besco Sp. z o.o.

ul. Kościelna 21

38-524 Besko, Polska

K: 600 700 336

T: 13 467 34 44

F: 13 467 34 44

email: info@besco.eu



INSTALLATION MANUAL

1-FOLD SHOWER SCREEN

PRIME I

Index:

PNP-1S





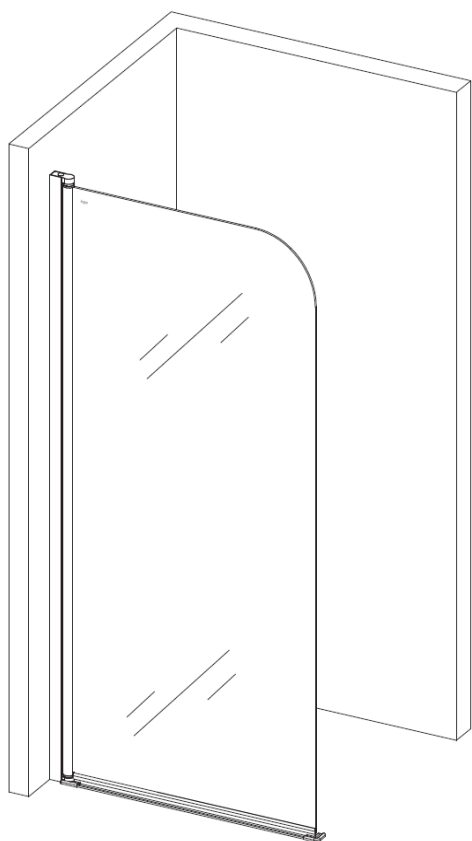





Dimensions:

70 x 140 cm







More information: www.besco.eu

LIST OF PARTS

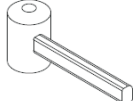
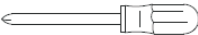
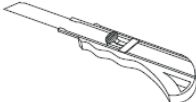
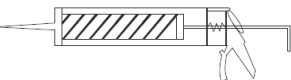
part number	index	description	IU	quantity	sketch
P01	PSPRUP01C1	PRIME wall profile, length 1400 mm, chrome	pcs.	1	
P02	PUPR1P02C1	PRIME aluminum sealing profile, length 620 mm, chrome	pcs.	1	
U01	UDPR1U01P1	PRIME bottom seal, length 635 mm, clear	pcs.	1	
M01	MPPRUM01C1	Cover / end cap for sealing profile, left / right set, chrome	pcs.	2	
M02	MPPRUM02C1	Cover / end cap for sealing profile, corner, chrome	pcs.	1	
M03	MBPRUM03C1	Cover / end cap for column hinge, chrome	pcs.	1	
W01	WKUUUW01D1	Mounting wall plug, Ø6 mm, white	pcs.	3	
W02	WRUUUW02C1	ST4x30 screw, chrome	pcs.	3	
W03	WZUUUW03C1	ST4x12 screw + chrome cover, set	pcs.	3	
S01	SRPR1S01P1	PRIME moving glass, flat, with column hinge, 1353 x 645 x 5 mm, transparent	pcs.	1	

SUGGESTED TOOLS

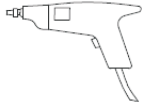
pencil		rubber hammer	
cross screwdriver		wallpaper knife	
clear sanitary silicone		Ø6 mm drill	
spirit-level		Ø3 mm drill	
measuring tape (min. 2 meters)		electric drill	

SHOWER SCREEN SCHEME

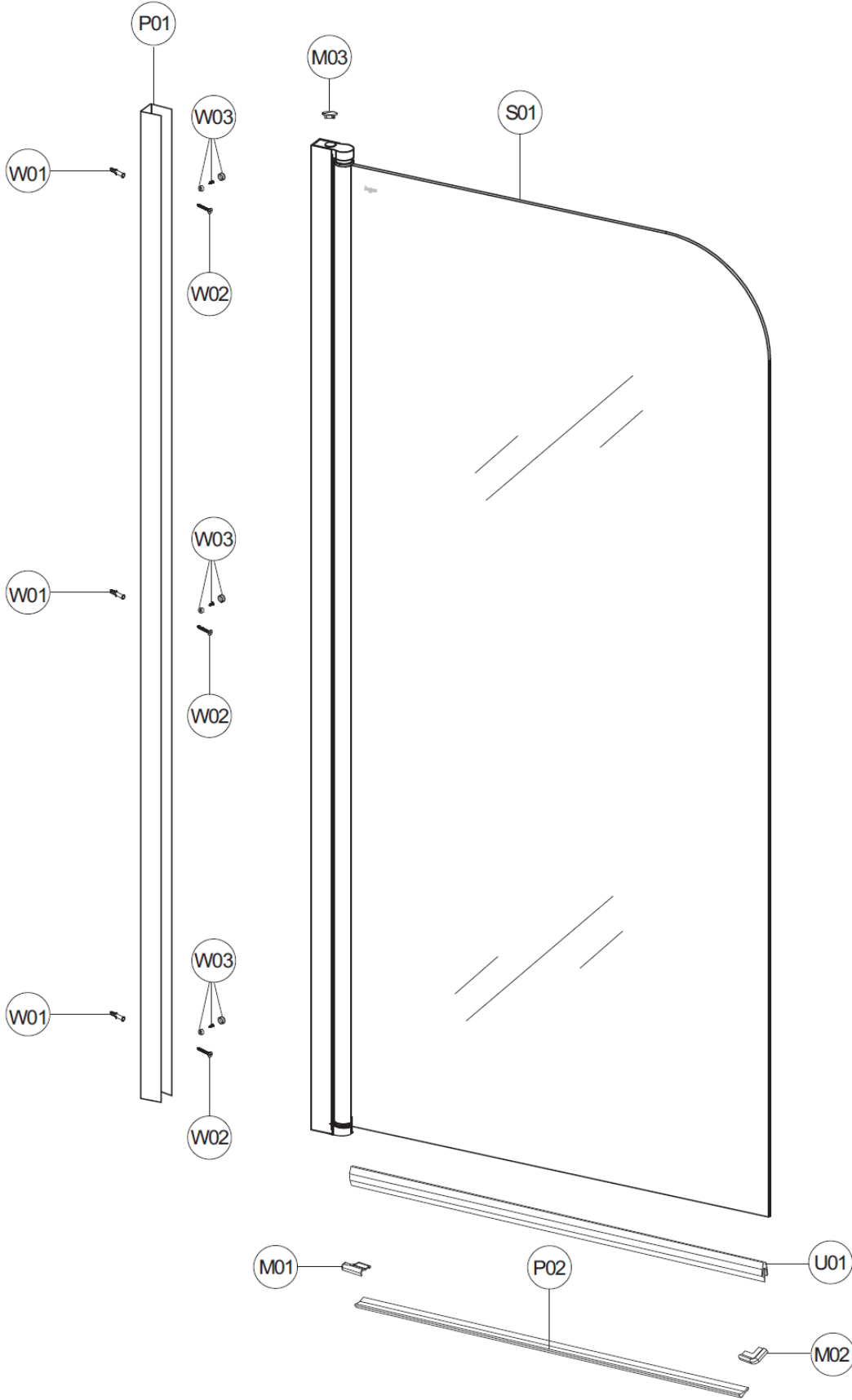

INSTALLATION MANUAL

1

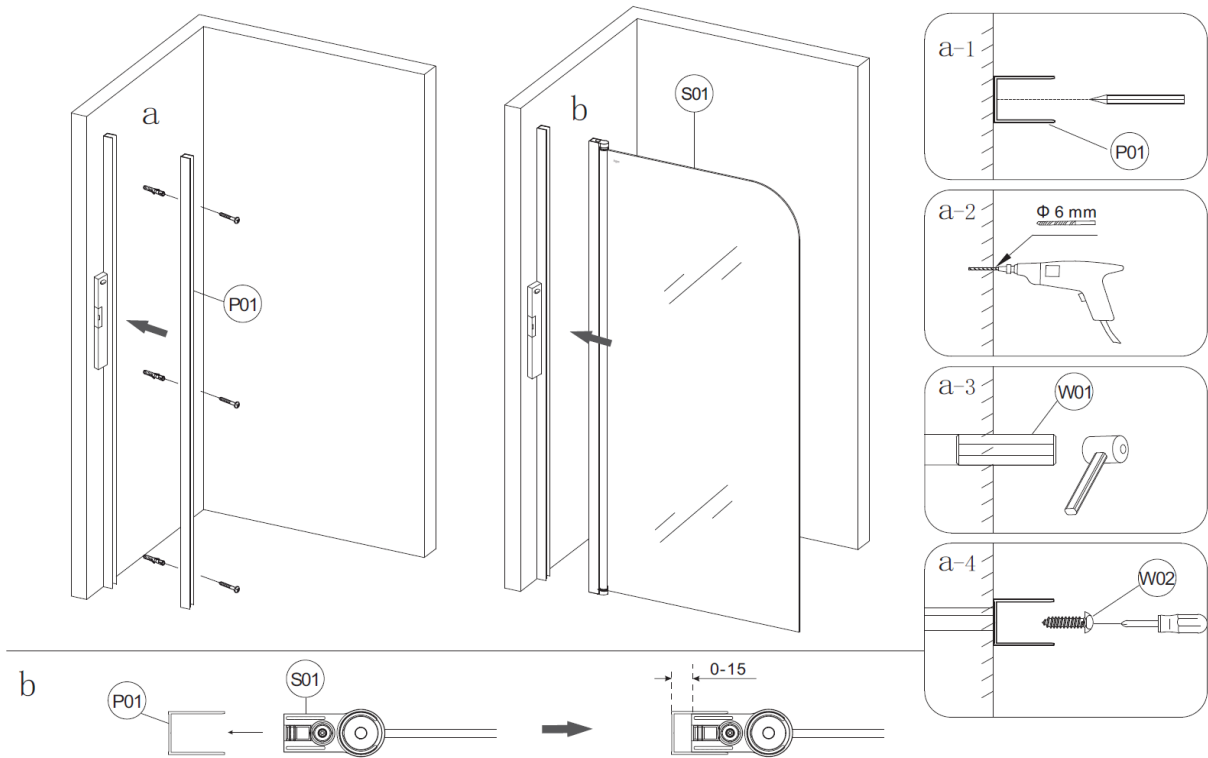

2

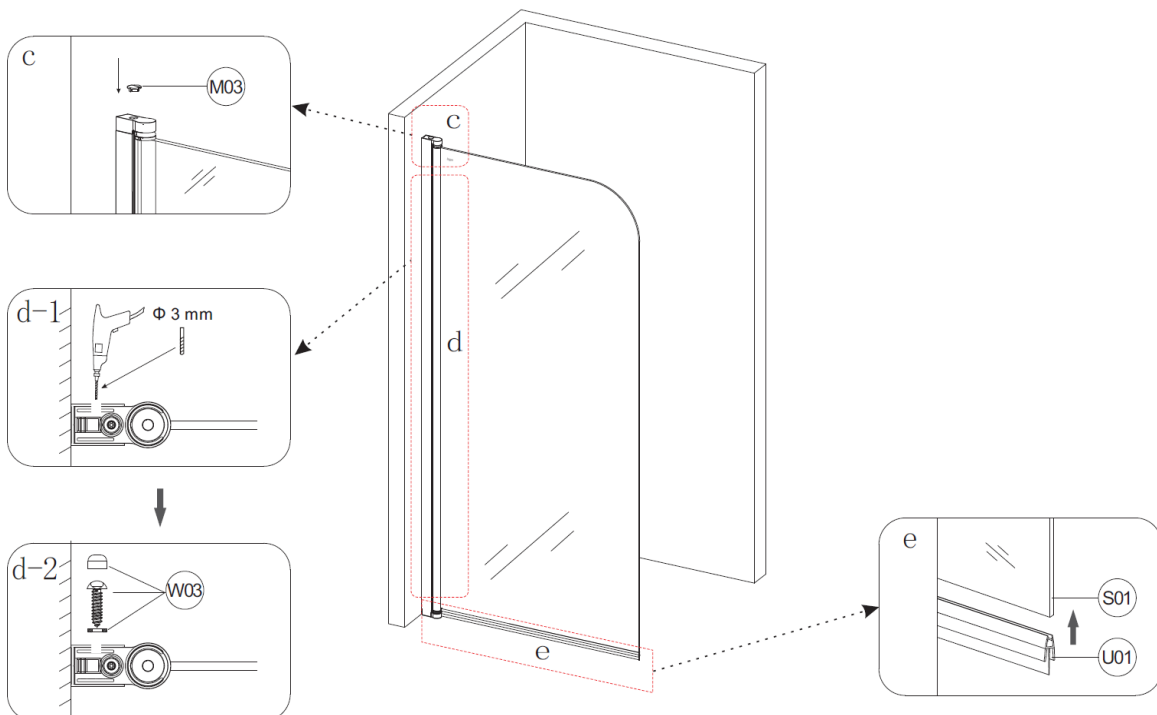

3

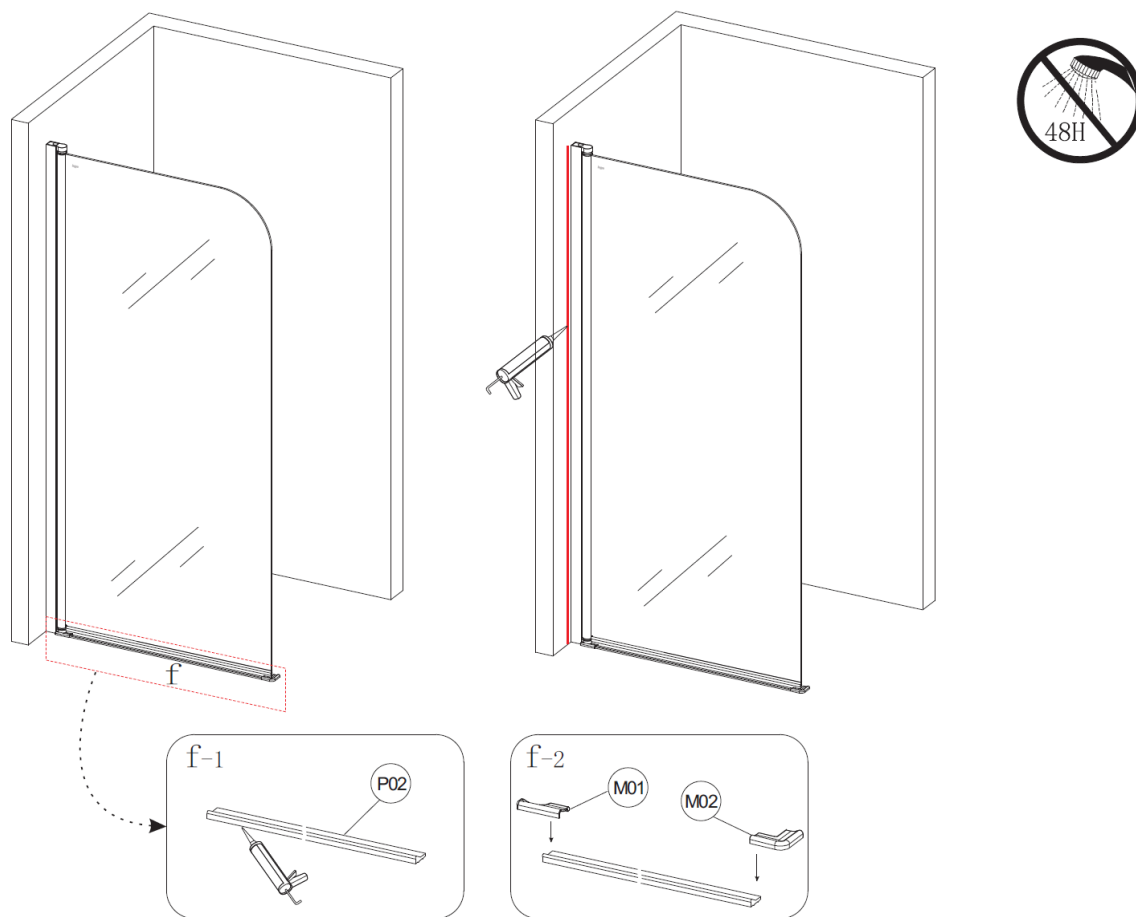

Recommendations regarding use:

After the installation of the shower screen is completed, the shower screen should not be used for at least 48 hours. Do not use caustic or abrasive substances for cleaning the shower screen.

Recommended care product:

Besco Professional "Shower enclosures & screens"

The most common mistakes made during assembly process:

- 1) The lack of proper surface levelling (bathtub)
- 2) Incorrect assembly of the glass panel with column hinge in the wall profile - the glass, after being placed in the wall profile, should be parallel to the edge of the bathtub
- 3) The lack of a proper leveling of the shower screen after placing it in the wall profile
- 4) Installation of so called "cold seal" - the seal should be stored at least 12 hours at room temperature before its assembly
- 5) The seal shortening - the seal is cut to a measure in the factory to match a particular model of the shower screen

How to maintenance Besco shower screens?



Just remember a few basic rules, to be able to enjoy your shower screen for many years.

It is important to use only soft sponges or cloths and liquids that do not contain corrosive substances or scrubbing particles, as they can easily damage the glass surface of the shower screen.

To make a daily care of our products a little bit easier and to ensure their comfortable use, we have introduced a professional cleaning agent for shower screens to our offer:

Besco Professional "Shower enclosures & screens"

CONTACT DETAILS:

Besco Sp. z o.o.

Kościelna 21

38-524 Besko, Poland

M: +48 600 700 336

T: +48 13 467 34 44

F: +48 13 467 34 44

email: info@besco.eu

